

SERRATURE DOPPIA MAPPA AD APPLICARE

MADE
IN
ITALY

20

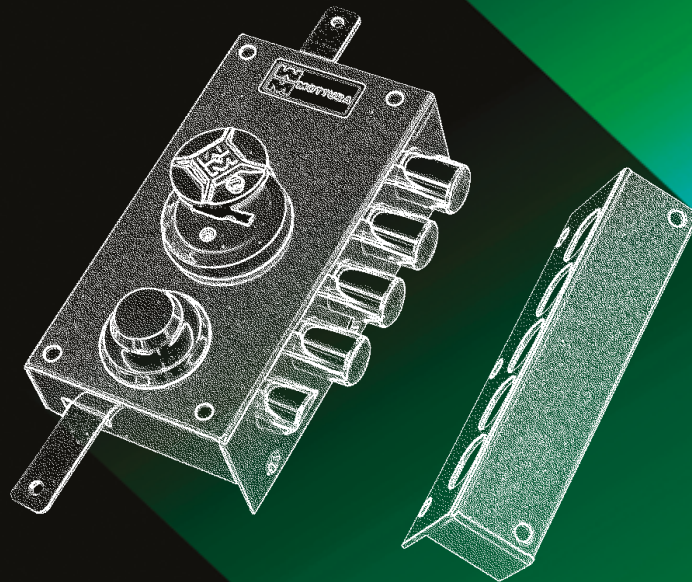

APPLICARE



safeguarding your security

20.537

MADE IN ITALY

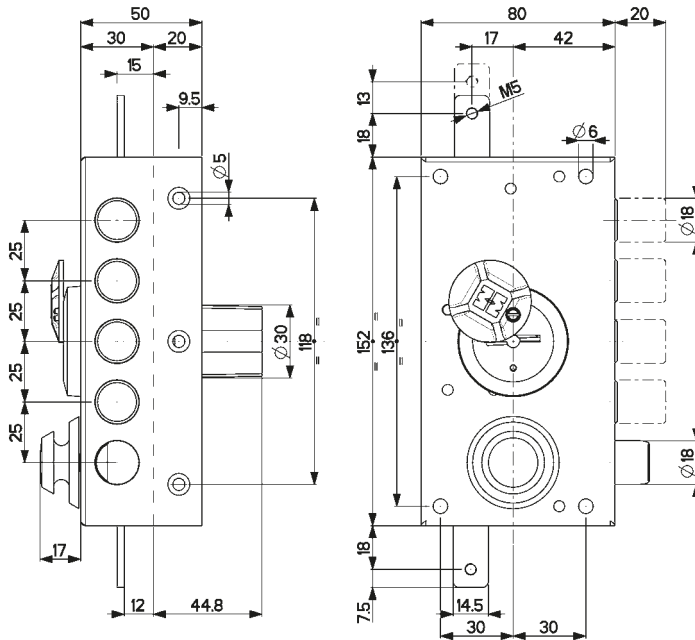

Caratteristiche

- Laterali o triplici
- Entrata chiave mm 42
- Corsa chiavistelli mm 20
- Tutti gli articoli sono forniti destri e sinistri (specificare nell'ordine)
- Finitura unica: Verniciata bronzo

Dotazione di serie:

Laterali - art. 20507/517

- n. 3 chiavi gambo mm 60, art. 92106
- n. 1 mostrina art. 95215
- n. 1 ferrogliera art. 94293
- viti e minuteria

Triplici - art. 20527/537

- n. 3 chiavi gambo mm 60, art. 92106
- n. 1 mostrina art. 95215
- n. 1 ferrogliera art. 94293
- n. 2 passanti aste art. 99292
- n. 1 cavallotto art. 99289
- n. 1 bocchetta a pavimento art. 99151
- viti e minuteria

ASTE NON COMPRESSE

Abbinare art. 93291

Avvertenza: l'applicazione in esterno richiede un trattamento "superficiale" in grado di offrire una maggiore resistenza agli agenti atmosferici. In questi casi, contattare l'azienda per stabilire versioni e quantità.

20.507

Finitura

Verniciata bronzo

Laterale



20.517

Finitura

Verniciata bronzo

Laterale con mezzo giro



20.527



Aste **NON** comprese







Finitura

Verniciata bronzo

Triplice Corsa aste mm 13



20.537		Aste NON comprese		
Finitura				
Verniciata bronzo				
Triplice con mezzo giro Corsa aste mm 13				

A RICHIESTA 1/2GIRO ROVESCIATO (aggiungere "R" al codice)		94.293	94.293A
99.135517D/S			
			
93.291	93.291L	96.293	
			

20.511



Caratteristiche

- Laterali
- Entrata chiave mm 63
- Corsa chiavistelli mm 36
- Tutti gli articoli sono forniti destri e sinistri (specificare nell'ordine)
- Finitura: Verniciata

Dotazione di serie :

- n. 3 chiavi gambo mm 60, art. 92106/5
- n. 1 mostrina art. 95223
- n. 1 ferrogliera art. 94128
- viti e minuterie

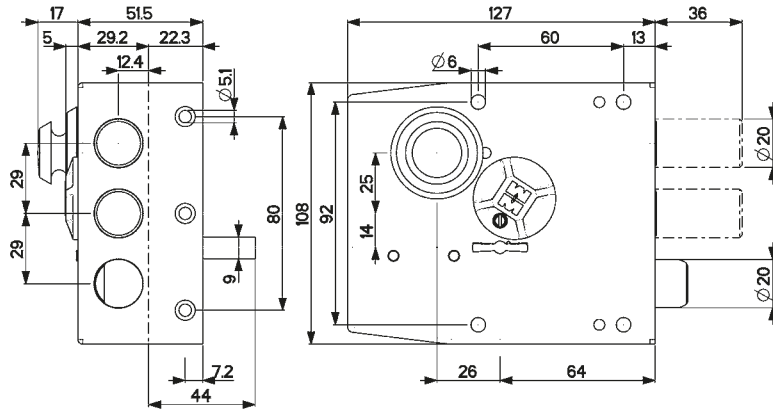

20.501

Finitura

Verniciata

Laterale



20.511

Finitura

Verniciata

Laterale con mezzo giro

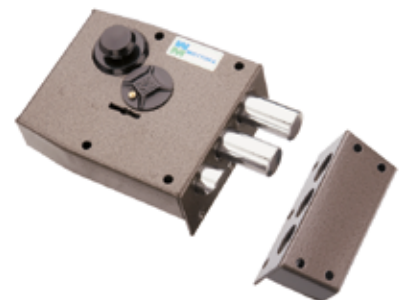

A RICHIESTA 1/2GIRO ROVESCiato (aggiungere "R" al codice)

99.135511D/S



94.128



20.550

MADE IN ITALY

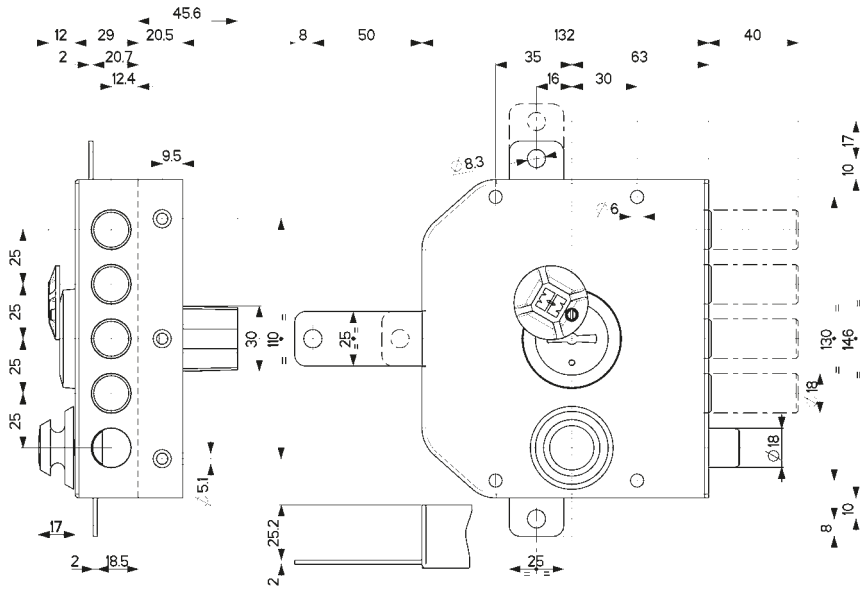

Caratteristiche

- Laterali, tripli o quintuplici
- Entrata chiave mm 63
- Corsa chiavistelli mm 40
- Tutti gli articoli sono forniti destri e sinistri (specificare nell'ordine)
- Finiture: Verniciata

Dotazione di serie:

Laterali - art. 20500/510

- n. 3 chiavi mm 60, art. 92315/4
- n. 1 mostrina art. 95147/4
- n. 1 ferrogliera art. 94122
- viti e minuteria

Tripli - art. 20520/530

- n. 3 chiavi mm 60, art. 92315/4
- n. 1 mostrina art. 95147/4
- n. 1 ferrogliera art. 94122
- n. 2 passanti aste art. 99152
- n. 1 cavallotto art. 99153
- n. 1 bocchetta a pavimento art. 99151
- viti e minuteria

Quintuplici - art. 20540/550

- n. 3 chiavi mm 60, art. 92315/4
- n. 1 mostrina art. 95147/4
- n. 1 ferrogliera art. 94122
- n. 2 passanti aste art. 99152
- n. 1 cavallotto art. 99153
- n. 1 bocchetta a pavimento art. 99151
- viti e minuteria

ASTE E DEVIATORE NON COMPRESI

20.500

Finitura

Verniciata

Laterale

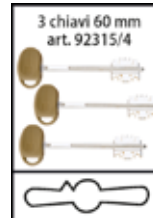

20.510

Finitura

Verniciata

Laterale con mezzo giro

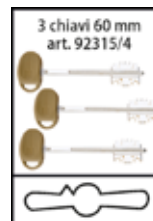

20.520

Aste **NON** comprese

Finitura

Verniciata

Triplice
Corsa aste mm 17

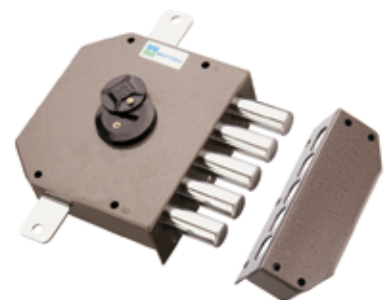
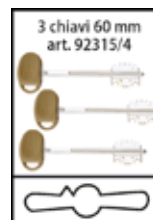

20.530		Aste NON comprese		
Finitura				
Verniciata				
Triplice con mezzo giro Corsa aste mm 17				
20.540		Aste e deviatore NON compresi		
Finitura				
Verniciata				
Quintuplice Corsa aste mm 17				
20.550		Aste e deviatore NON compresi		
Finitura				
Verniciata				
Quintuplice con mezzo giro Corsa aste mm 17				

A RICHIESTA 1/2GIRO ROVESCIATO (aggiungere "R" al codice)		93.140	93.141	96.143
99.135530D/S				
94.122 - BASSA	94.122M - BASSA	94.125 - ALTA		

PER ACCESSORI E RICAMBI SERIE 20 VEDI CAPITOLI

	RICAMBI GORGES	91	92	CHIAVI	
	ASTE	93	94	FERROGLIERE	
	MOSTRINE	95	96	DEVIATORI	
	RICAMBI VARI	99			